

SEUIC

Reference Manual

Reference Manual for UTouch2-2.0Q8-11
RFID Hand-held Terminal

Version 1.1

Table of Contents

Document issuance record	1
Chapter I Instructions for Use	1
1.1 Precautions for laser scanning engine	1
1.2 Safety precautions	1
1.3 Maintenance precautions	1
Chapter II Appearance Introduction	3
Chapter III Keyboard	4
Chapter IV Quick use	6
4.1 First use	6
4.2 Power on	6
4.3 Power off	6
4.4 Restart	6
4.5 Installation of SIM card	6
4.6 Installation of Micro SD card	7
4.7 Installation of battery	7
Chapter V Charging	9
5.1 Charging time	9
5.2 Charging temperature	9
5.3 Power supply by battery	9
5.4 Precautions on battery use	9
5.5 LED indicator	9
Chapter VI Home screen	11
6.1 Status bar icon	11
Chapter VII Settings	13
7.1 WLAN	13
7.3 SIM card	15
7.4 Data usage	15
7.5 More	16
7.5.1 Airplane mode	17
7.5.2 Android Beam	17
7.5.3 Network sharing and portable hotspots	17
7.5.4 VPN	17
7.5.5 Mobile network	18
7.5.6 Reset of network settings	20
7.6 Display	20
7.7 Notifications	23

7.8 Sound	24
7.9 Application	25
7.10 Storage	25
7.11 Battery	26
7.12 Location information	27
7.13 Security	27
7.14 Account	28
7.15 Languages & input	29
7.16 Backup and reset	29
7.17 Date & time	30
7.18 Accessibility	31
7.20 Developer options	31
7.21 About phone	32
Chapter VIII Introduction to Typical Applications	34
8.1 Scan tool	34
8.2 UHF	38
8.2.1 Inventory tag interface	39
8.2.2 Interface of ReadWrite tag	40
8.2.3 Parameter setting interface	41
8.2.4 Application setting interface	43
8.2.5 Menu key	45
8.2.6 Troubleshooting	45
8.3 System upgrade	45
8.4 Quick configuration	48
8.4.1 Import	49
8.4.2 Export	52
8.5 Feature settings	53
8.5.1 Glove mode of touch screen	54
8.5.2 Disable status pull-down	54
8.5.3 Virtual key for block 1	55
8.5.4 Virtual key for block 2	55
8.5.5 Virtual key for block 3	55
8.5.6 Prohibit passing the key value of the scan key to the application	55
8.5.7 Display Scan float button	55
8.5.8 Disable drop detection	55
8.5.9 Allow File app to install applications from unknown sources (install third-party apk) ..	56
8.6 Digital certificate whitelist	56
Chapter IX Troubleshooting	59
Introduction to optional accessories	61

Chapter I Instructions for Use

1.1 Precautions for laser scanning engine



To avoid laser radiation, users should not look directly into the laser beam.

1.2 Safety precautions

- Your device can only use batteries and chargers specified by the company; use of non-specified ones may cause the battery to leak, overheat, burst and catch fire.
- Do not short-circuit the charger, otherwise it may cause electric shock, smoke and damage to the charger.
- Please do not use the charger if the power cord is damaged, otherwise it may cause fire and electric shock.
- Please do not disassemble or modify the charger, otherwise it may cause personal injury, electric shock, fire and damage to the charger.
- Hold the charger when pulling out the plug. Pulling on the power cord can damage the wire, causing electric shock and fire.
- Clean the device, battery, and charger with a soft, dry cloth.
- Do not wipe the device with solutions such as alcohol, thinner, or benzene.

1.3 Maintenance precautions

- This product is waterproof and dustproof, but operation in extremely high or low temperatures or wet environments should still be avoided. Please refer to the product specifications for temperature and humidity standards.
- Pressing the screen too hard may damage the screen. Do not use a resistive touch pen to tap the screen to avoid scratching or damaging the screen. To clean the screen, spray a small amount of commercial LCD screen cleaner onto a soft cloth. Avoid spraying the cleaner directly on the screen.
- Do not use any chemical cleaners to wipe the LCD screen.
- Keep the scanning window clean and stain-free, and do not use sharp objects to mark it.
- For a long-term suspension of use, be sure to download the data to your computer for storage.

- For first use or reuse after a long suspension, the device's battery will take a long time to be charged.
- If you find a failure, please write down information on its occurrence and contact the maintenance personnel.

Chapter II Appearance Introduction

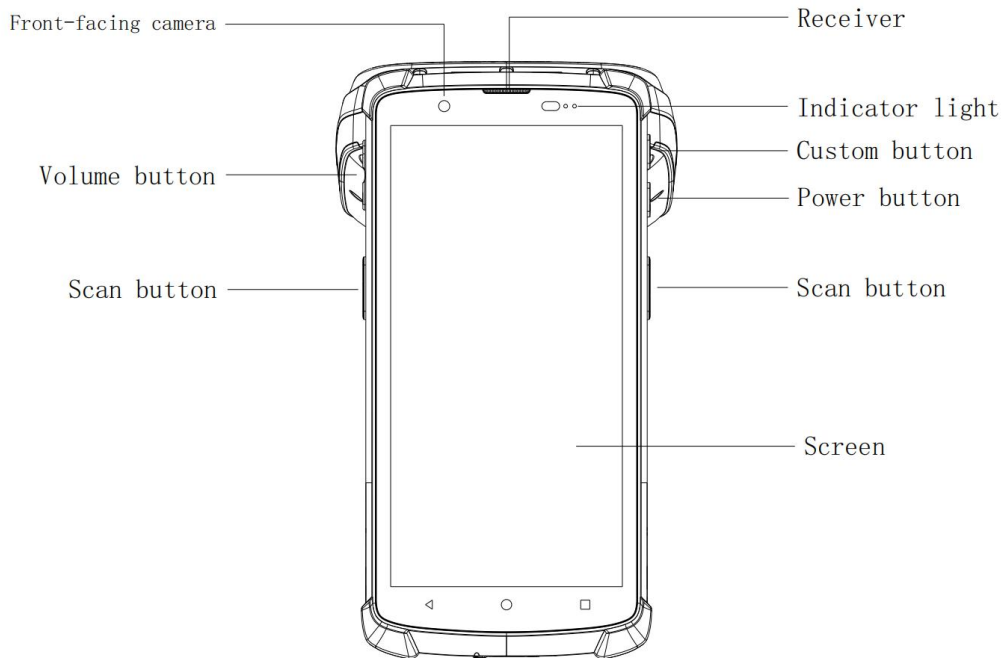

Figure 2-1 Front view

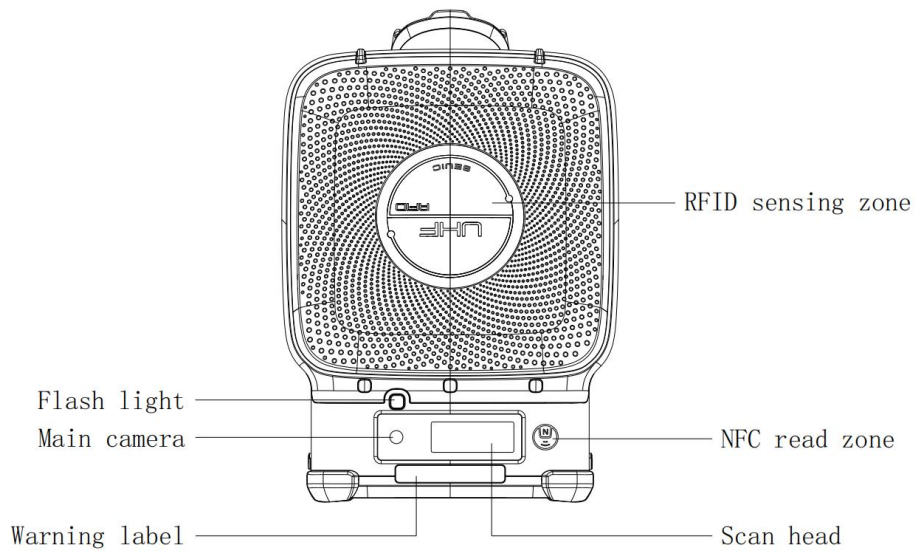

Figure 2-2 Front view

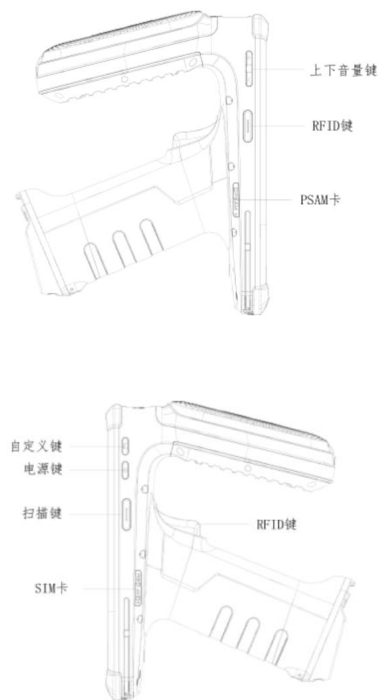

Figure 2-3 Side view

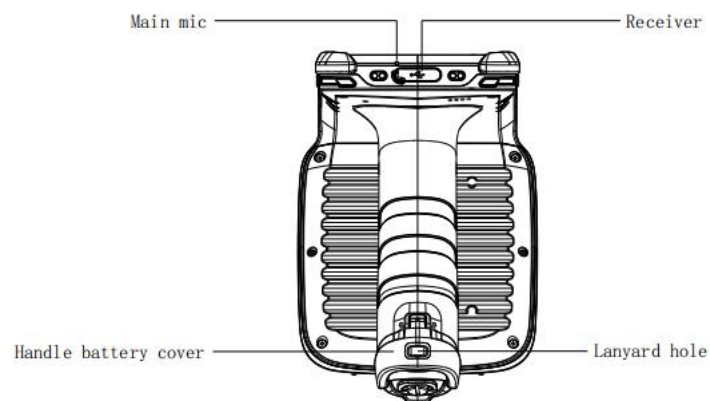

Figure 2-4 Rear view

















Chapter III Keyboard

The UTouch2 RFID handheld terminal has a total of 8 keys, including 3 virtual ones on the screen

touch panel (i.e., Back, Home, and Menu), 4 on the side (i.e., PPT, volume, left scan, and right scan) , and 1 scan key on the handle.

Description of keys:

Table 3-1 Introduction of keys

Key	Main function	Features
	Home key	Click  to return to the home screen.
	Menu key	Click  to open Task Manager.
	Back key	Click  to return to the previous interface or exit the application. In the text input interface, click  to close the on-screen keyboard.
	Power key	In standby mode, short press  to sleep/wake up the device. In shutdown mode, press and hold  for 3 seconds to power on the device.
	Volume key	Press the upper part of  to volume up the system, and the lower part of  to volume down the system
	Left scan key	UHF scanning
	Right scan key	Barcode scanning
	Custom key	Reserve customer-defined keys
	Handle scan key	In barcode mode, start the barcode scanning In UHF mode, start/stop the tag inventory
1.Screenshot shortcut key: Press and hold Power + Volume down keys at the same time		

Chapter IV Quick use

4.1 First use

- Press and hold the Power key for 3 seconds to power on the device. When the system is working, short press the Power key and the device will enter the Sleep state; in the Sleep state, short pressing the Power key will wake up the system and light up the screen.

4.2 Power on

- You can power on the device by pressing the Power key. In the Deep sleep mode, short press the Power key to wake up the system. If the device is powered by a battery, make sure the battery is in reliable contact.

4.3 Power off

- When the device is powered on, press and hold the Power key for 2 seconds in Non-sleep mode to open the Options menu, select Power off, and click OK to power off normally.

4.4 Restart

- When the device is powered on, press and hold the Power key for 2 seconds in Non-sleep mode to open the Options menu, select Restart, and click OK to restart normally.

4.5 Installation of SIM card

- To install the SIM card, please follow the instructions below:
- Insert the SIM card in the direction shown in the figure.

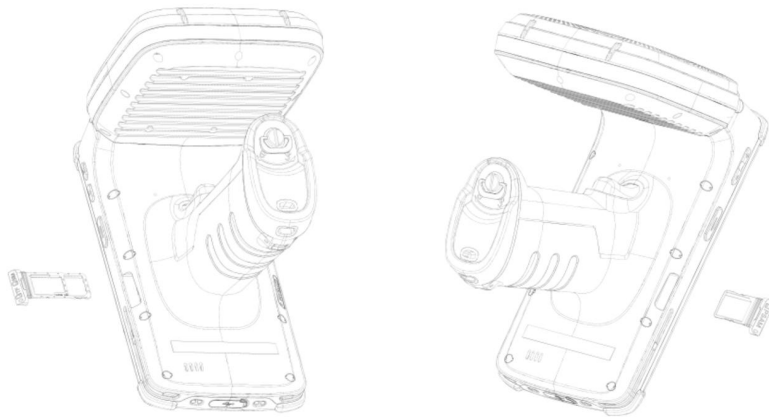

Figure 4-1 Inserting SIM card (1: SIM card, 2: PSAM card)

4.6 Installation of Micro SD card

- To install the Micro SD card, please follow the instructions below:
- Insert the SD card (microSD or microSDHC) in the direction as shown.

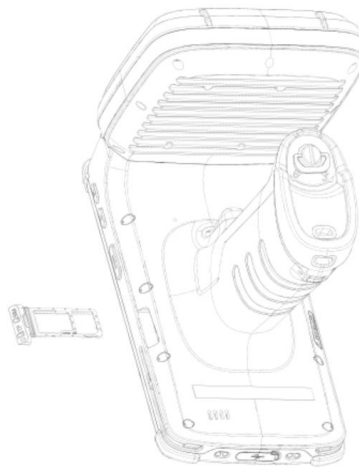

Figure 4-2 Inserting SD card

Note: This device supports hot-swapping of SD cards

4.7 Installation of battery

- The battery of this product is removable. Please follow the steps below when installing the battery:
- Unscrew the screws of the battery compartment cover, open the battery compartment cover,

and replace the battery.

- It is not recommended to replace the battery frequently.



Figure 4-3 Battery compartment cover

Chapter V Charging

- Since the battery only has a small amount of power for testing when it leaves the factory, be sure to charge it before use when you receive the device.

5.1 Charging time

- Battery: It takes about 3 hours to charge the battery for the first time through the adapter. When the battery is charged, the LED light stays red, and when the battery is fully charged, the LED light stays green.

5.2 Charging temperature

- The optimal operating temperature is the room temperature (18~25°C).
- The battery will not be charged when the temperature is below -10°C or above 50°C.

5.3 Power supply by battery

- If you turn on wireless network services or data collection programs, the battery power will be quickly used up. When not using these functions, be sure to turn off these programs to save power.
- Tip: For a long-term suspension of use, please charge the whole device at least once every two months.

5.4 Precautions on battery use

- If the battery power is exhausted, it may not turn on immediately when plugged in the charger. This is normal. Please continue charging for 30 minutes before turning on the device.
- The battery can be charged repeatedly, but it is a consumable product. If you find the standby time of the device is significantly reduced, please replace it with a new battery.
- The battery charging time varies with temperatures and battery usage. Please charge within the temperature range of -10°C~50°C.
- When the battery power is low, the device will pop up a prompt of low battery. When the battery power is too low, the device will automatically shut down.

5.5 LED indicator

- The LED indicator in the middle of the upper right corner of the device indicates the battery

status and charging status of the device with different colors:

- ✧ When the USB, charging adapter, or interface for micro SD card is not plugged in, the red light flashes to indicate that the battery power is too low

and it must be charged in time;

- ✧ When the USB, charging adapter, or interface for micro SD card is plugged in, it stays red to indicate that the battery is charging;
- ✧ When the USB, charging adapter, or interface for micro SD card is plugged in, it stays green to indicate that the battery is fully charged.
- When the LED indicator in the middle of the upper right corner of the device flashes blue (like a breathing light), indicating that there are unread messages, please check them in time.
- The LED indicator on the left side of the upper right corner of the device flashes red once, when a barcode is scanned; it does not flash, when no barcode is scanned.
- Note: When the system is charging, the blue indicator will not be on.

Chapter VI Home screen



Find this icon, Settings-Application, click the Settings button in the upper right corner of the interface to enter the Settings home screen. There are two home screens by default, which can be set at will.

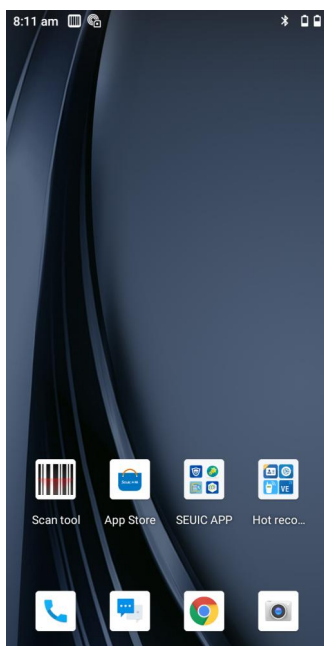

Figure 6-1 Home screen (Trebuchet)























Table 6-1 Home screen items

① Status bar: It displays notifications and status icons.
② Display area: Used to place application icons, desktop folders and widgets.
③ Shortcut bar: Click to enter the corresponding application.
④ Application tray: Click or slide up to enter the main interface to view all applications.

6.1 Status bar icon

Status icons and notification bar icons are located in the status bar at the top of the screen, which display device status information and notifications, as shown in the table below.

Table 6-2 Status icons and notification bar icons

Icon	Description	Icon	Description
	Available Wi-Fi network detected		Signal strength
	Connected to Wi-Fi network		No SIM card inserted
	Uploading data		Downloading data
	Portable Wi-Fi turned on		Mobile network connected
	Do-not-disturb mode		Airplane mode
	Vibration mode		Scan on
	Missed call		Charging batteries
	New message		Battery fully charged
	Screenshot captured		Battery low
	Alarm clock		Headphone plugged in
	Preparing microSD card		
	USB debugging, USB connection		

Chapter VII Settings

7.1 WLAN



Find this icon:

->Settings

->Network and Internet

->WLAN

The 2.4G Wi-Fi provides a wireless network access as far as 450 feet (150m), and the 5G Wi-Fi provides a wireless network access as far as 300 feet (100m) (note: industrial-grade AP, in open fields). To use Wi-Fi on your device, you must connect to a wireless access point or [hotspot].

Note: The availability and coverage of Wi-Fi signals depend on the volume, infrastructure, and other objects the signal penetrates.

Turn on Wi-Fi and connect to the wireless network

1. Click the WLAN off/on button to turn on Wi-Fi. Automatically scan for available wireless networks.
2. Then the list of Wi-Fi networks will display the name and security settings (open network or encrypted network) of the Wi-Fi networks found.
3. Touch one of the Wi-Fi networks to connect. When you select an open network, you will automatically connect to it. If you select an encrypted network, you must enter the password before touching to connect.

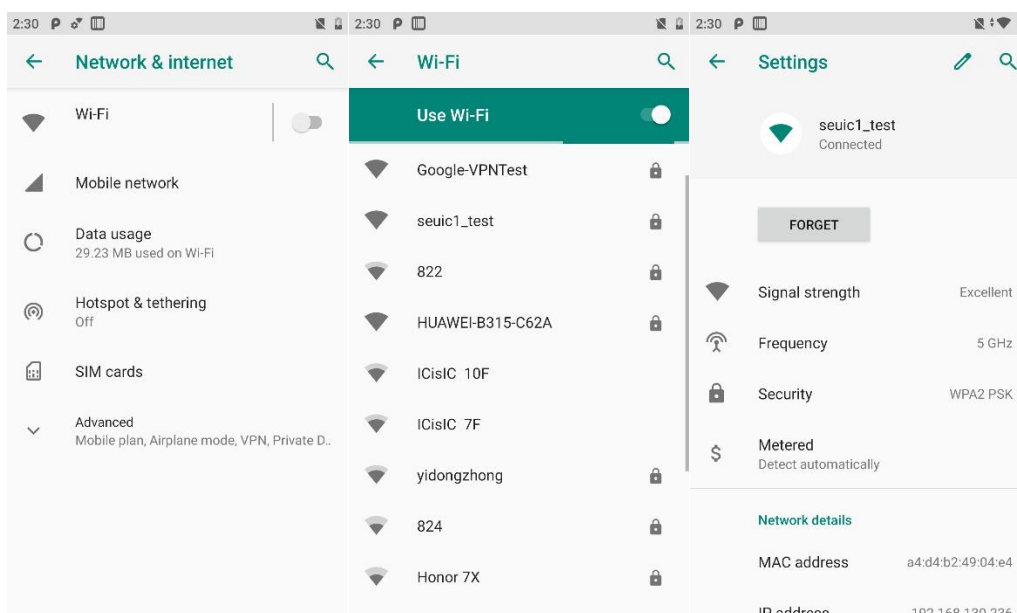

Figure 7-1 Wi-Fi menu

4. WLAN band settings (click WLAN preference settings at the bottom of WLAN - Advanced WLAN settings - WLAN band settings). When you choose to use only the 5GHz/2.4GHz band, only APs in the 5GHz/2.4GHz band can be searched.

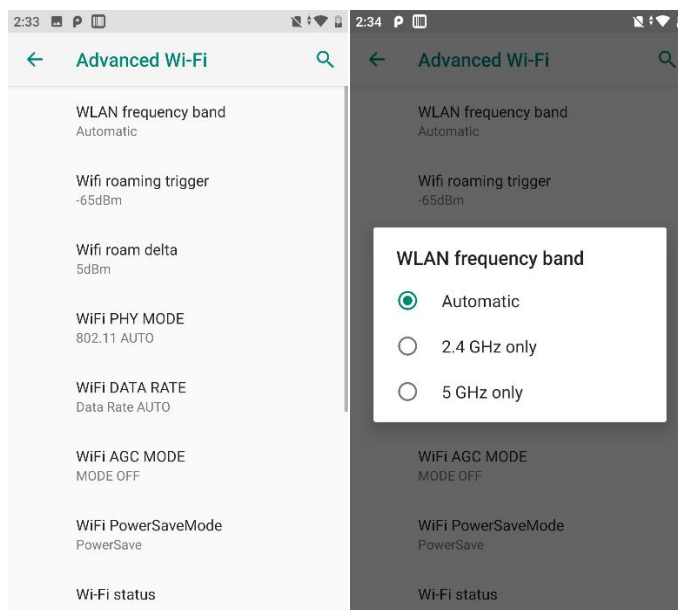



Figure 7-2 WLAN frequency band

- Open the interface at Wi-Fi network and touch to scan. The Wi-Fi network found will be displayed in the list of Wi-Fi networks.
- Click on another Wi-Fi network to connect to it

7.3 SIM card

Find this icon: 

- >Settings
- >Network and Internet
- >SIM card

At the SIM card interface, the preferred SIM card (including data traffic, calls, and text messages) can be set and SIM functions can be disabled. The main interface is shown below:

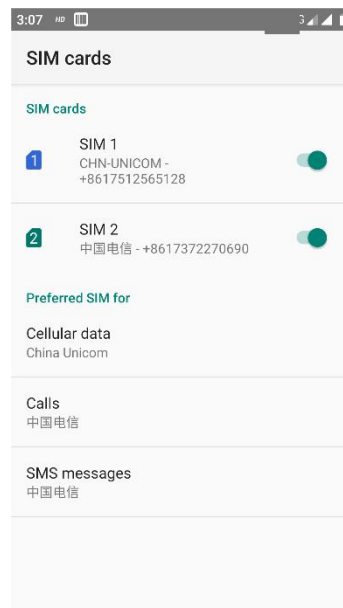



Figure 7-8 Main interface of SIM card

7.4 Data usage

Find this icon: 

- >Settings
- >Network and Internet
- >Traffic usage

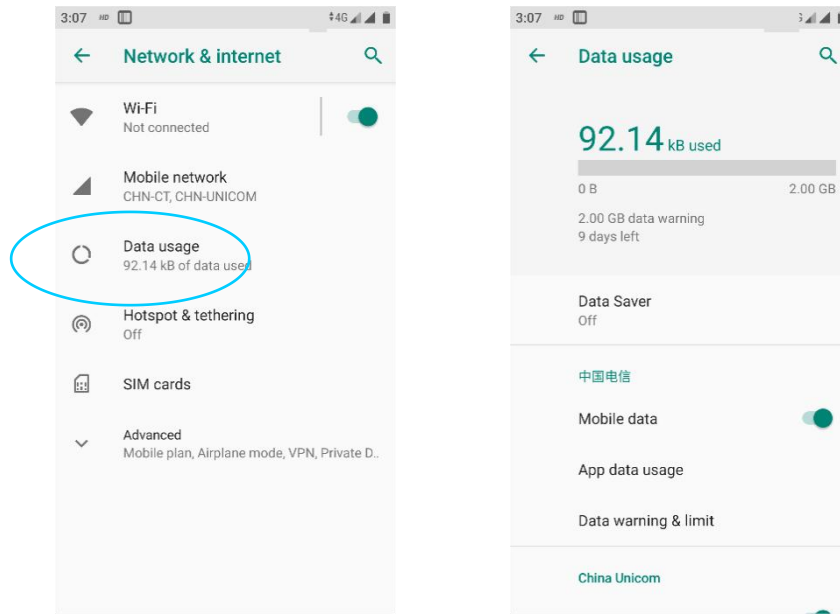

Figure 7-9 Traffic usage

7.5 More

Find this icon:

- >Settings
- >Network and Internet
- >Advanced

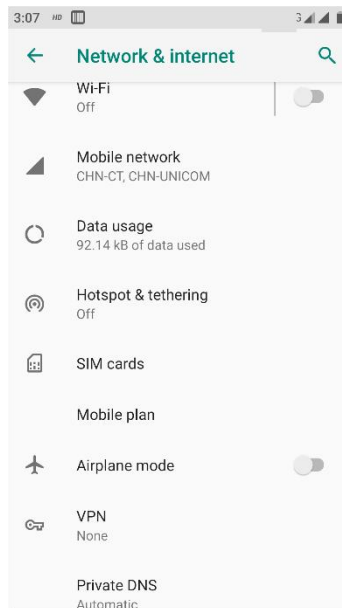

Figure 7-10 More menus

7.5.1 Airplane mode

After checking the airplane mode, the wireless module will be automatically turned off.

7.5.2 Android Beam

When the Android Beam function is enabled, the device can share files through Android Beam.

7.5.3 Network sharing and portable hotspots

(1) The portable hotspot function turns the device into a Wi-Fi hotspot to provide access for mobile phones and computers equipped with Wi-Fi modules within a certain range.

(2) Settings---->Network and internet---->Hotspot & tethering---->Wi-Fi---->Enable, as shown in the figure:

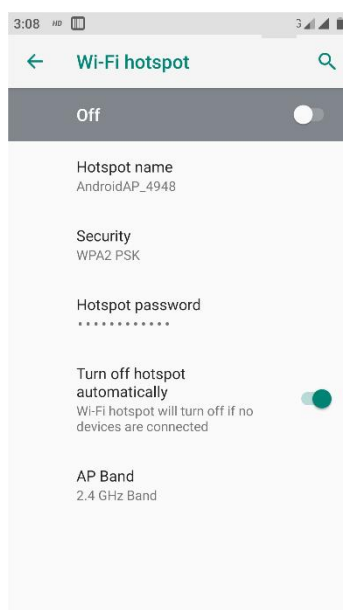

Figure 7-11 Modifying WLAN hotspots

In this interface, you can click on the place to be modified for modification.

7.5.4 VPN

After enabling the VPN, you need to add a dedicated VPN network (for example when you want to access the company's internal file server and other network shared resources). No matter where you are, you can connect to the company's VPN server through the VPN client, you can dial up through the VPN client after obtaining the VPN account, and you will be able to access the company's shared resources after the dial-up is successful.

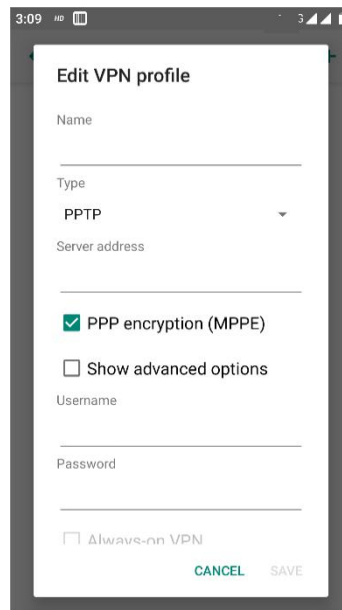

Figure 7-12 VPN settings

7.5.5 Mobile network

1. Enable: After entering the roaming environment, data communication can be directly switched to the roaming state.

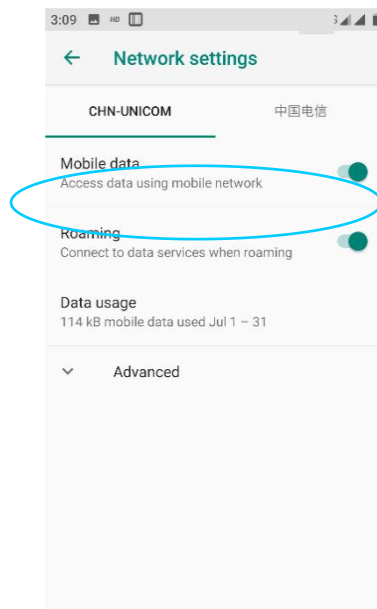

Figure 7-13 Mobile data network roaming

2. Preferred network type: After selecting the corresponding network type priority, the taskbar will display the corresponding network signal indication: 2G preferred=2G prioritized, 3G preferred=3G prioritized, and 4G preferred=4G prioritized. If 2G network is selected as prioritized

for the China Unicom card, the device will be forced to downgrade to 2G network even under the coverage of 3G network.

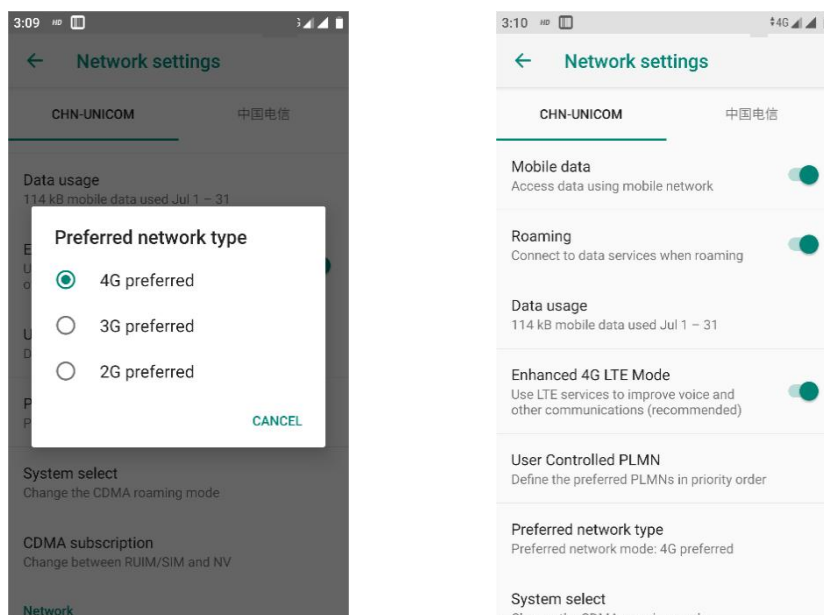

Figure 7-14 Network mode selection

3. The access point is generally designated as cmnet by default for China Mobile, 3gnet by default for China Unicom, and ctnet by China Telecom, as shown in the figure:

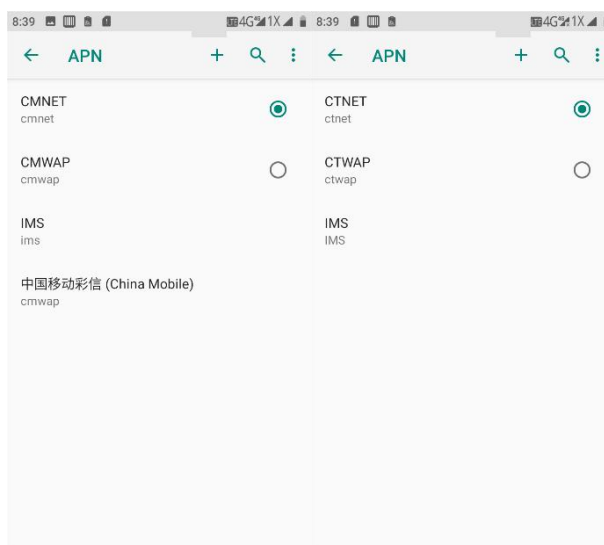



Figure 7-15 Access point APN

4. To add a dedicated APN, click this  button, and the interface shown below will pop up. Generally, add a name (custom), APN (network access point), user name, password, etc. Press the Menu key to select Save to complete the addition. Press the Menu key to give up or press the Back key to return directly to give up saving. If you want to modify or delete the APN added, click to enter the interface to modify, and press the Menu key to save or delete.

Note: In adding APNs, users can set other options as required according to their own access point needs.

5. Network operator: Search for network operator resources in the current environment.

7.5.6 Reset of network settings

This function will reset some WLAN and mobile data network related settings of the device. Click the [Reset Settings] button to jump to the interface to confirm the reset of network settings. Click [Reset Settings], and it will prompt that the reset is successful, as shown in the figure below:

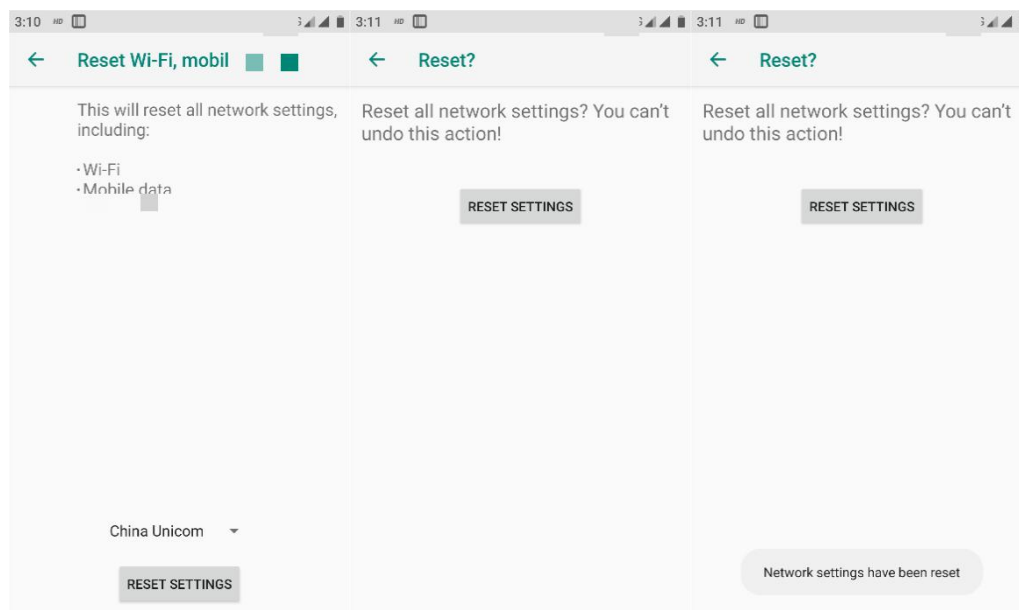

Figure 7-16 Resetting network settings

Note:

1. Connect the device to Wi-fi. After resetting the network settings, the device will clear the AP password and disconnect
2. Disable the Enhanced 4G LTE mode in the mobile data network. After resetting the network, the device enables the Enhanced 4G LTE mode function by default

7.6 Display



Find this icon:

->Settings

->Display

1. Brightness. You can move the cursor bar left and right to adjust the backlight.

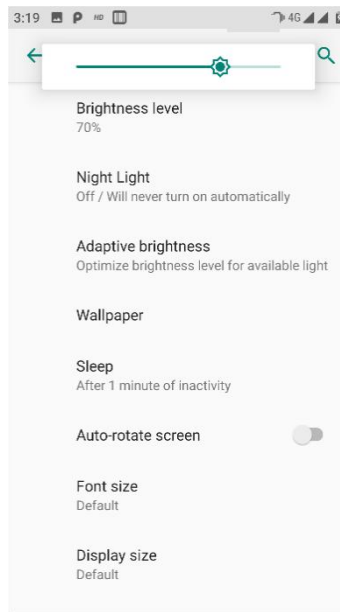

Figure 7-17 Display

2. Wallpaper. After entering here, you can modify the source of the wallpaper you want to set at will, such as the picture gallery, photo album or memory card. Wallpaper: The system comes with pictures by default.

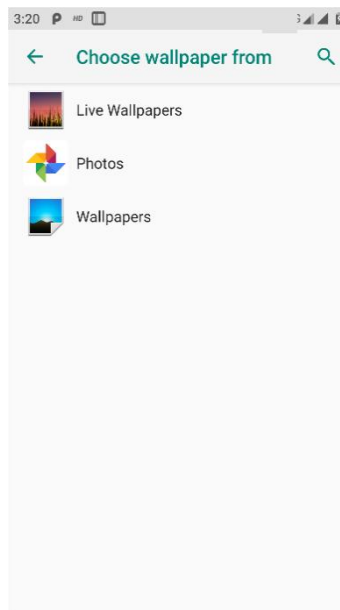

Figure 7-18 Wallpaper

3. Auto-rotate screen. Select the rotational direction of the screen content. The device rotates to shift between horizontal and vertical screens according to the rotation angles.

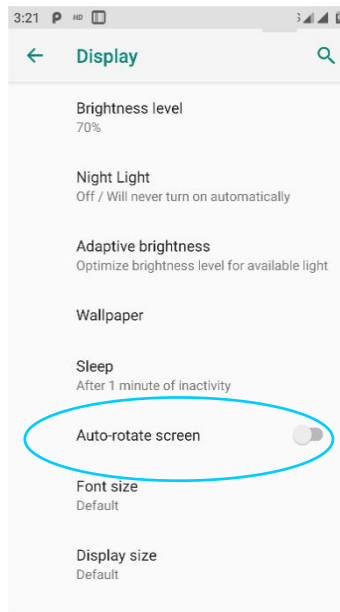

Figure 7-19 Automatically rotating the screen

4. Sleep. Change the system sleep time setting. After the set time is up, the system will automatically sleep.

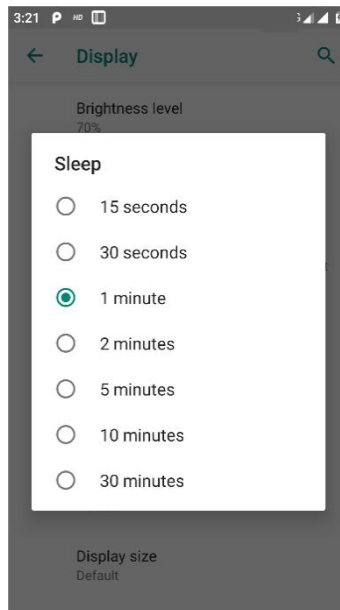

Figure 7-20 Sleeping

5. Font size. Adjust the system font size according to your own needs, with small, default, large and maximum for option.



Figure 7-21 Font

7.7 Notifications

Find this icon: 

->Settings

->Apps and notifications

The settings for application notifications include notifications, default apps, application permissions, and special application permissions. As shown below:

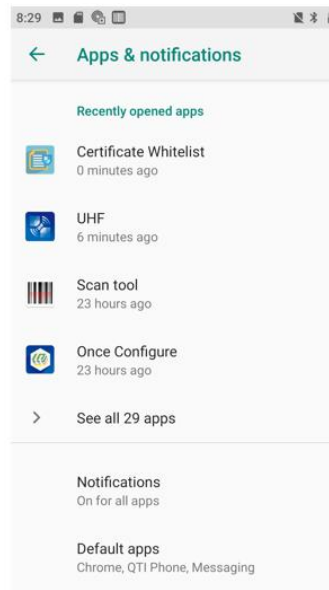

Figure 7-22 Notification

7.8 Sound



Find this icon:

->Settings

->Sound

Volume, ringtone and default notification sound settings. You can also select or cancel Vibrate on ringing, Dial pad tones, Touch sounds, Charging sounds, Screen locking sounds and Touch vibration by turning them on or off, as shown below:

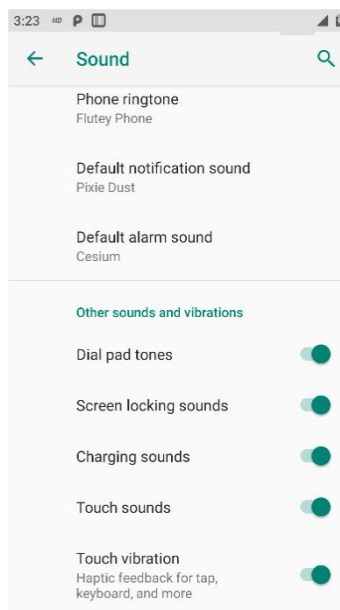

Figure 7-23 Sound

7.9 Application



Find this icon:

->Settings

->Apps and notifications

Manage the applications. Enter the interface, click on the application you want to uninstall to enter the following application information interface, click Uninstall, and then you can remove the application from the device.

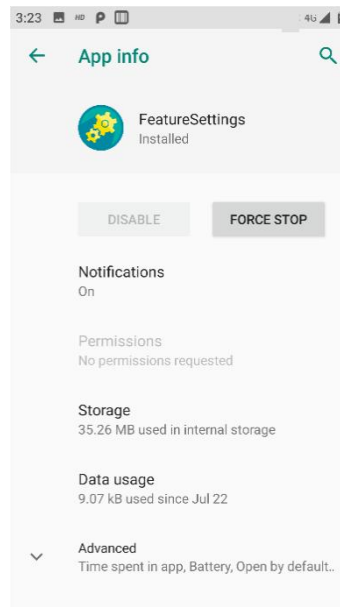

Figure 7-24 Application

7.10 Storage



Find this icon:

->Settings

->Storage

To view the available storage space, clear the memory card (format the internal memory) and select the option to perform a media scan on the external memory card or external USB device.

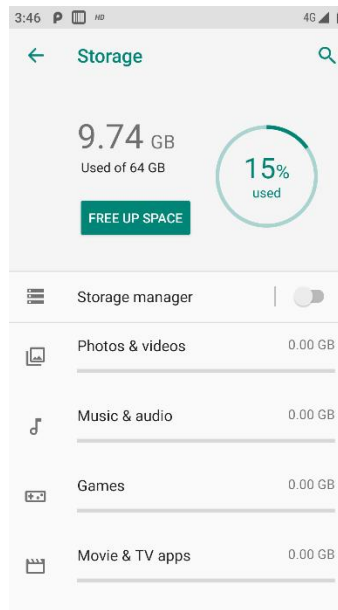



Figure 7-25 Storage

7.11 Battery

Find this icon: 

->Settings

->Battery

You can see the current capacity of the battery, and whether or not the battery level is displayed on the status bar when it is turned on and off.

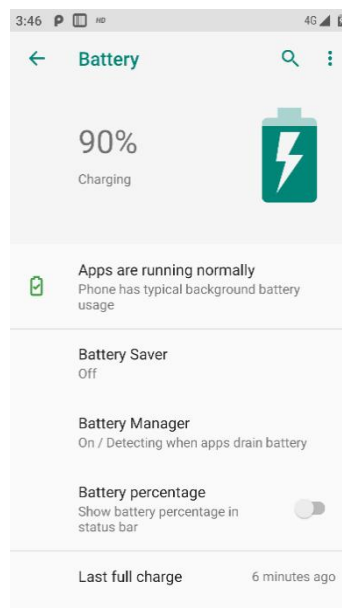

Figure 7-26 Battery

7.12 Location information



Find this icon:

->Settings

->Security & location

Check Google's location service, and enable the GPS positioning function to voluntarily download the third-party positioning software.

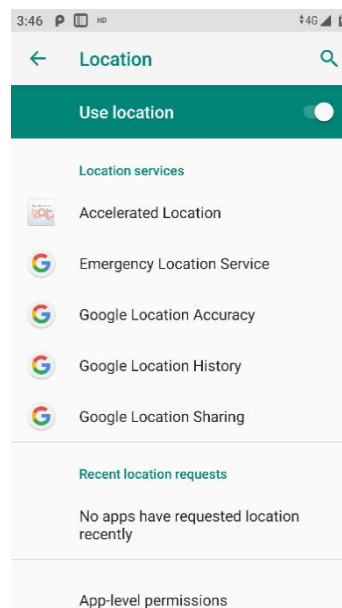

Figure 7-27 Right to use location information

7.13 Security



Find this icon:

->Settings

->Security & location

Set the screen locking method, display password, device manager, app actions, unknown sources, password settings for installing unknown-source apps, trusted credentials, etc.

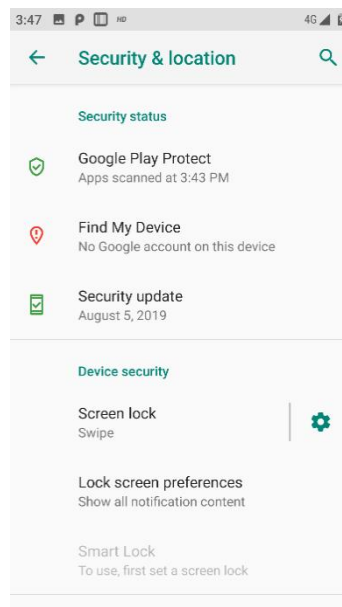

Figure 7-28 Security

7.14 Account



Find this icon:

->Settings

->Account

Add an account and synchronize information (you can synchronize contact information, calendar, etc. to the cloud of other products, by setting an account and the server side).

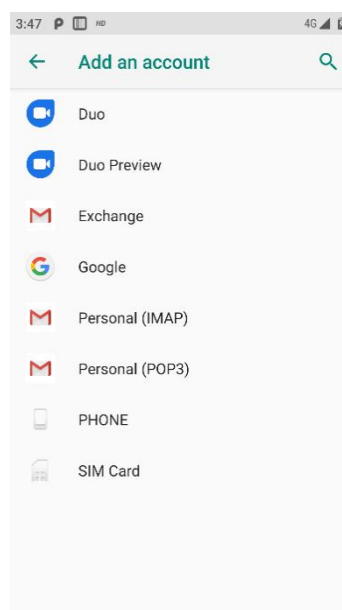



Figure 7-29 Adding an account

7.15 Languages & input

Find this icon: 

->Settings

->Languages & input

Language selection, text input and automatic error correction options. Select your favorite keyboard and input method, and set the text-to-language output and pointer speed. If other input methods are installed, they will be displayed on this interface.

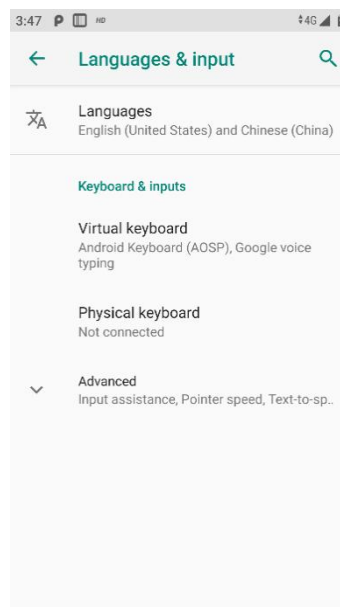



Figure 7-30 Languages & input

7.16 Backup and reset

Find this icon: 

->Settings

->Backup and reset

Back up or restore data, and restore factory settings.

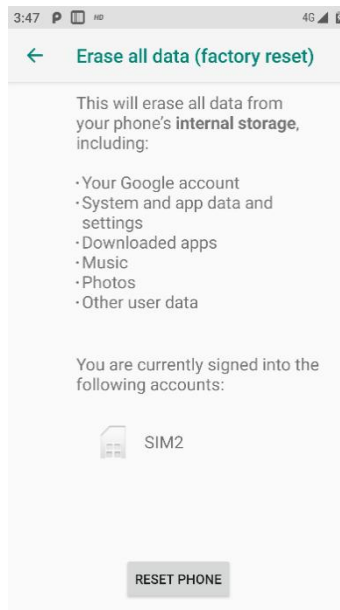



Figure 7-31 Restoring factory settings

7.17 Date & time

Find this icon: 

->Settings

->Date & time

You can use the time or time zone provided by the network, or manually set the date and time, and select the time zone. You can also choose the display format of the time and date.

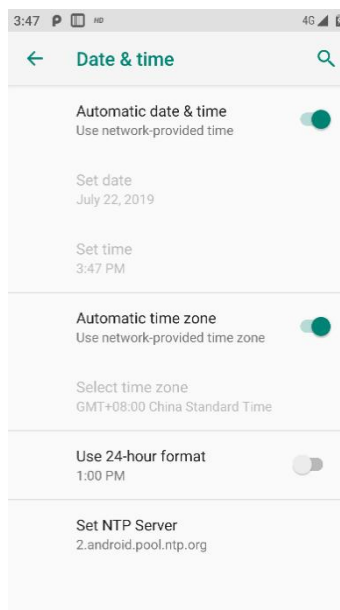

Figure 7-32 Date and time

7.18 Accessibility



Find this icon:

->Settings

->Accessibility

Here you can set the magnification gestures, high-contrast text, pressing the power button to end a call, mono audio, color inversion, color calibration, and touch and hold delay.

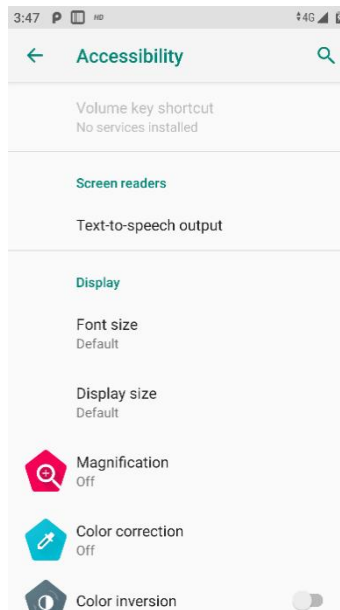

Figure 7-33 Accessibility

7.20 Developer options



Find this icon:

->Settings

->Developer options

Settings-->About phone-->Version number, click the version number multiple times to open the developer options, and obtain some other information on the device, common to Android devices.

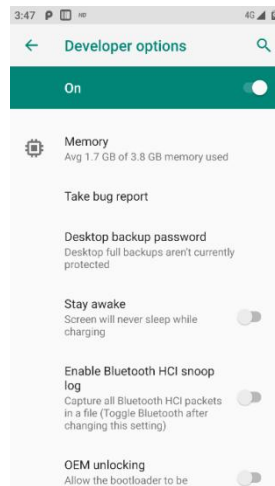

Figure 7-34 Developer options

7.21 About phone



Find this icon:

->Settings

->About phone

Detailed information of device:

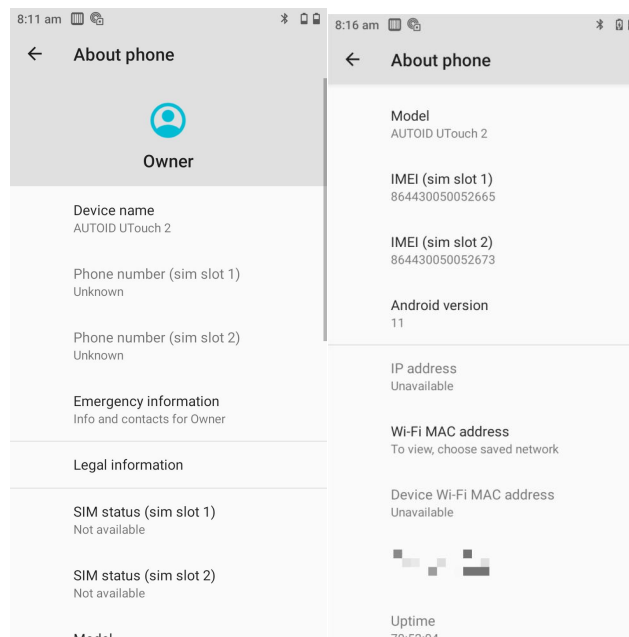

Figure 7-35 About phone

- For SIM status information, you can view the current network, signal strength, IMEI number, etc. as shown in Figure 7-39;
- Model: Model of the local device;
- Function number: Function number of this device;
- Android version: Android system version;
- Build number: Module version number;
- Touch screen firmware version number: Touch screen version number;
- Device serial number: S/N number of the device;
- Kernel version: Device kernel information;
- Build number: Software version of the device system.

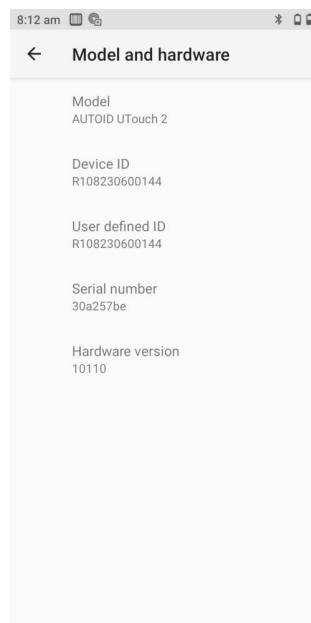



Figure 7-36 Model & hardware

Chapter VIII Introduction to Typical Applications

Applications

8.1 Scan tool

1. Find this icon , open this interface, and press Scan to scan normally.

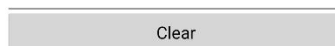
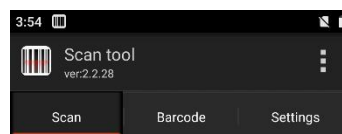

Figure 8-1 Main interface of scanning tool

2. Select [Barcode Settings] to enter the barcode type setting interface and set the required barcode type;

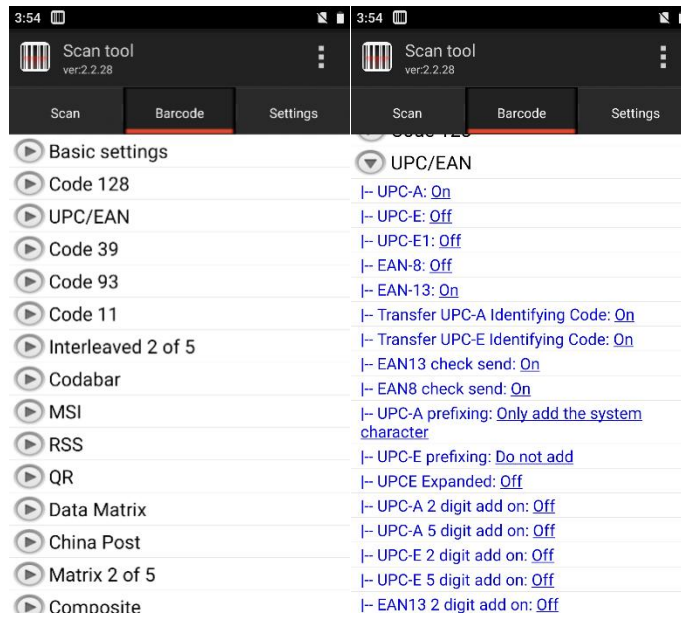

Figure 8-2 Barcode settings

3. Open [Basic Settings] to set the scanning duration, angle, timeout, etc.:

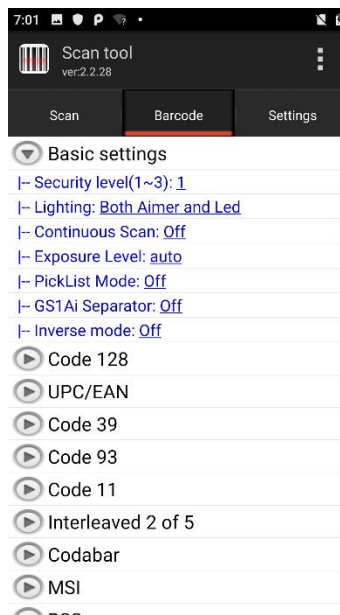
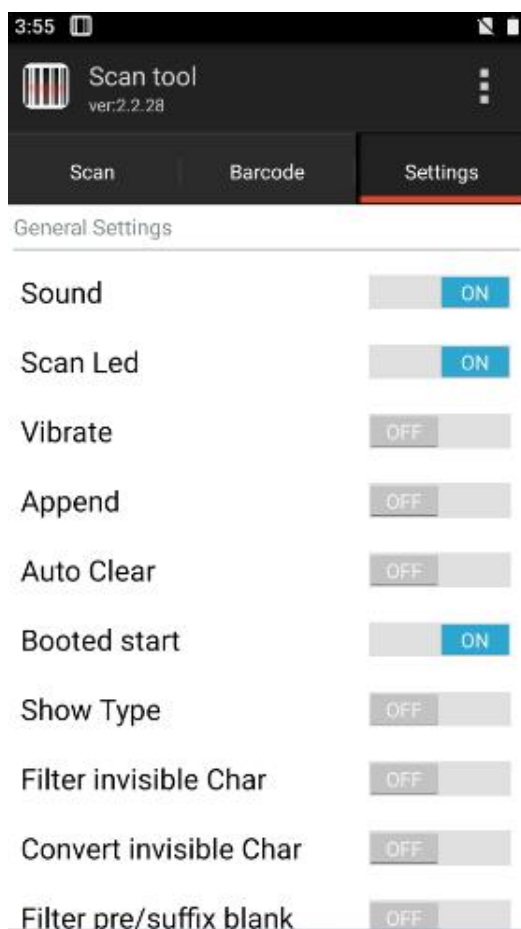

Figure 8-3 Basic settings

4. Open [General Settings] to set the basic scanning switches, as shown in Figure 8-4:

- Sound: When turned on, there will be a sound prompt for scanning;
- Vibrate: When turned on, there will be a vibration prompt for scanning;
- Append: Open to continuously output barcodes;
- Auto Clear: After scanning the barcode, the previous barcode will be automatically cleared;
- Boosted start: If turned on, the scanning program will automatically start when the computer is turned on;
- Show Type: If turned on, the barcode type will be displayed when scanning the barcode;

- Stop scan on up: If turned on, the scanning light will go out immediately when the scan key is released; if turned off, the scanning light will go out [scan duration] after the scan key is released;
- Loop Scan: If turned on, it will scan continuously;
- Interval: Set the time by yourself, i.e., the interval between the completion of scanning the barcode and the scanning of the next barcode;
- Restore: You can restore default barcode settings, as shown in Figure 8-5;
- Suffix: You can add the barcode output suffix by yourself (numbers, letters, special characters, etc.);
- Prefix: You can add the barcode output prefix by yourself (numbers, letters, special characters, etc.);
- End Char: You can choose the barcode output ending character, including: Enter, Tab, Space, and None;
- Barcode Send Model: You can choose to send it by Focus, Broadcast, EmuKey (select the input method supporting hard keyboard), or Clipboard, as shown in Figure 8-6;
- Developer options: Enter the password 888888, and you can modify the developer options (preferably not to change at will), as shown in Figure 8-7.



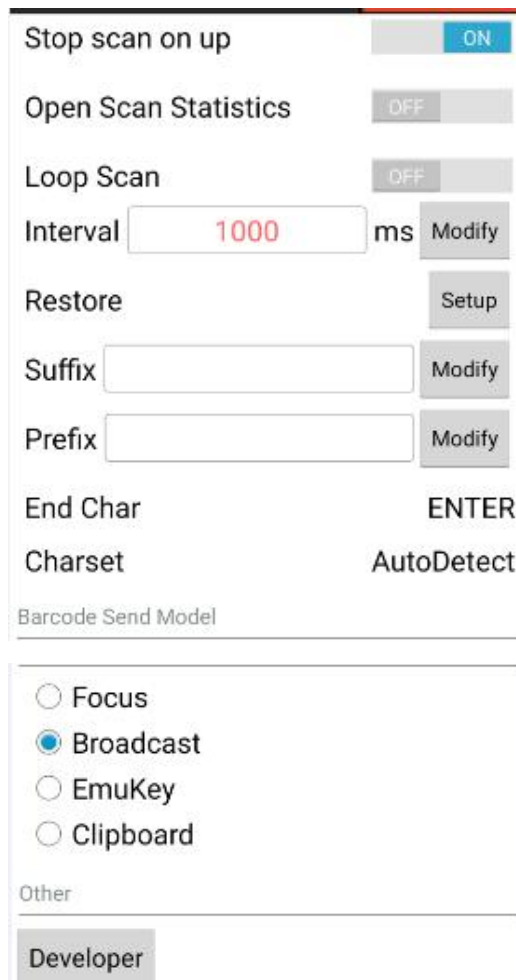

Figure 8-4 Application settings

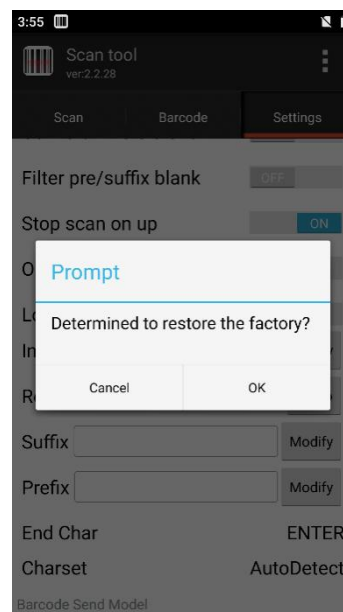

Figure 8-5 Restoring default barcode settings

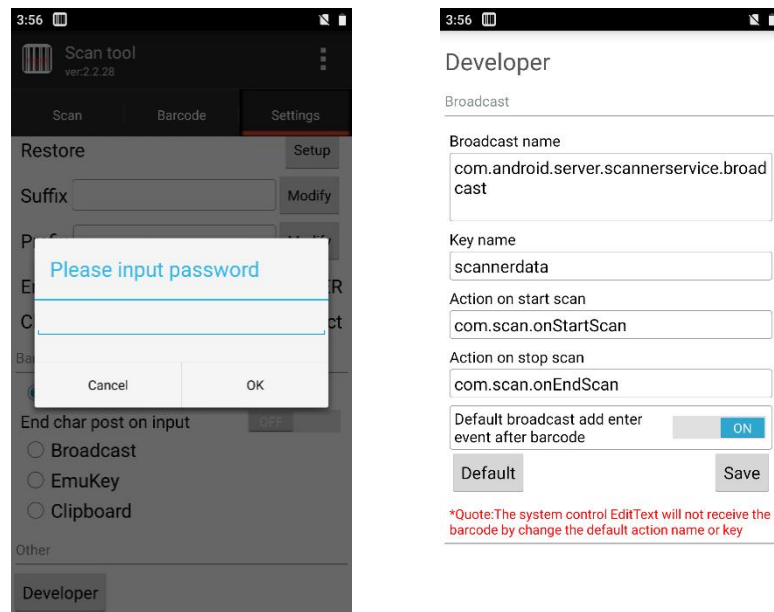

Figure 8-6 Developer options

5.Hide or exit program

- (1) Select [Hide], the program will run in the background, and you can scan by pressing Scan on any editing interface;
- (2) Select [Exit] and the program will exit and close.

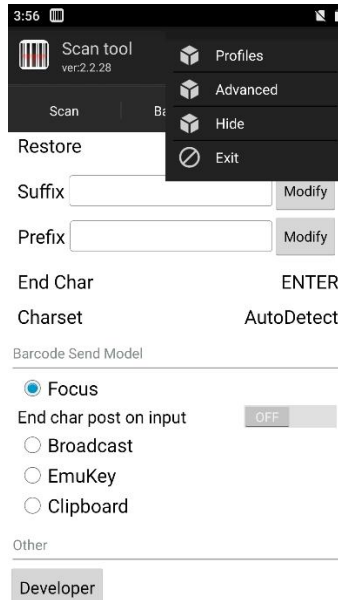



Figure 8-7 Hide and exit

8.2 UHF

Find this icon  on the startup desktop and click the icon to enter the UHF application.

8.2.1 Inventory tag interface

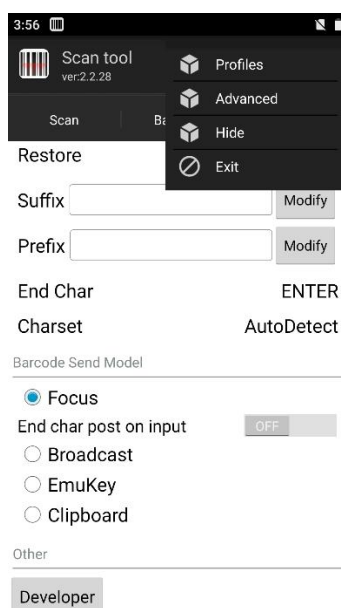

Figure 8-8 Inventory tag interface

Click to start inventory, and the device will seek cards by the set working method

- Single: When selected, the device will only seek cards once in a single operation.
- Continuous: When selected, the device will continuously seek cards when working until it stops working.
- Filter: After checking, enter the corresponding conditions, and the loop card seek will seek tags according to the corresponding conditions. If you check the filter condition, enter the filter condition starting data 0, length 2, filter data 3000, and filter area EPC; select matching; click Confirm; click Start Inventory, then the tags with the EPC data of the card search tag 3000xxxx will be filtered out.
- Clear: Click to clear the current card seek data.
- Number of tags: Total number of current tags seeking cards.
- Recognition times: Total number of times currently seeking cards.
- Serial number: Sort the current card seek tags.
- Tag EPC: EPC data of card searching tags.
- Times: Number of times the current tag has searched for cards.
- RSSI: Signal strength when the tag is found.
- Additional data: When turned on, the additional data content of the tag will be displayed.

8.2.2 Interface of ReadWrite tag

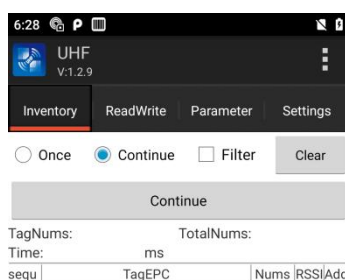

Figure 8-9 Interface of ReadWrite tag

1. Tag selection: You can select read tags and perform read and write operations.
2. Read and write tags

Read-write card: Select a found tag, select the read-write card area, enter the corresponding read-write card conditions, and click the read-write card to complete the read-write card operation.

Example description:

- Read card: Select the Read card area as the password area, and set the starting address to 0, length to 8, and access password to 00000000. Select a tag, click the Read card key, and it will prompt that the card reading is successful, and the device will successfully read the password area of the card. Card data is displayed in the data content box;
- Write card: Select the card writing area as the password area, set the starting address to 0, length to 8, and access password to 00000000, and the data content is 1122334455667788. Click Write card, and it will prompt that the card writing is successful. The device writes the card to the password area successfully, with card-writing data of 1122334455667788 (Note: The EPC writing card starting address starts from 4, the first four digits are the check code and PC number, the check code changes automatically, and the PC number determines the EPC data length).
- Select card reading/writing area: PASSWORD area, User area, EPC area, and TID area can be selected.
- Starting address: Used with card reading/writing. Select the address bit to read or write.
- Length: Used with card reading/writing. Select the length to read or write.
- Access password: Used with card reading/writing. It is the password used when reading or writing data to the card.
- Data content: Used with card reading/writing. It displays the content of data currently read or

written.

- Read card: Read the data at the set location, and the read data will be displayed in the data content above the Read card key.
- Write card: Write the data at the set location. Please enter the data to be written in the data content above the Write card key.
- Clear: Clear the data in the data content box above the Read card/Write card.

3. Lock tag

After the tag is locked, you cannot use the default password (8 zeros) to write to the card. You can only use your own password to write to the card.

- Locking area: Lock a certain area of the tag, with EPC area, TID area, USER area, and password area optional.
- Lock type: Lock the tag. You can choose to unlock the tag, lock the tag, permanently lock the tag (it cannot be unlocked after the operation), or permanently unlock the tag (after the operation, the tag cannot be locked again).
- Access password: Password for locking the tag, 8 zeros by default, the first 4 bytes being the destruction password, and the last 4 bytes the access password.

4. Destroy tag

To destroy this tag (the destroyed tag is permanently invalid, which cannot be restored. Please use it with caution)

- Destruction password: (First 4 bytes of the password area). First modify the destruction password of the password area to non-0, and then operate with the modified password. (The destruction password must be non-zero to take effect).

8.2.3 Parameter setting interface

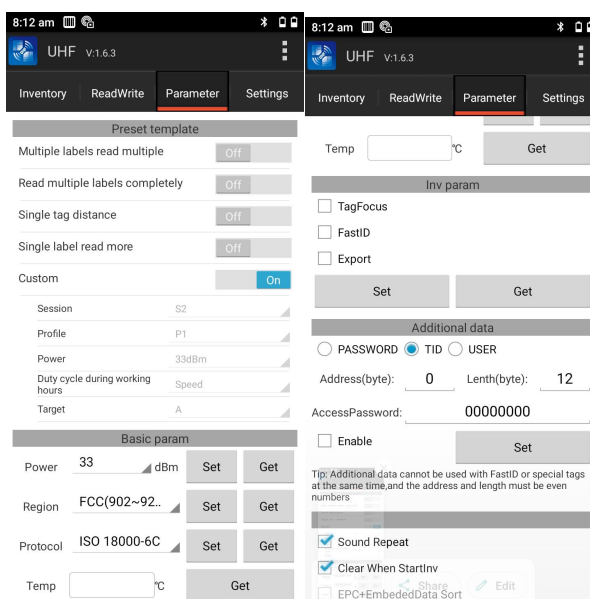

Figure 8-10 Parameter setting interface

1. Basic parameters

- Power: You can obtain and set the power of the current card-searching antenna.
- Working frequency band: You can obtain and set the working frequency band of the current device.
- Working protocol: You can obtain and set the protocol supported by the current device.
- Temperature: The current chip temperature can be obtained.

2. Query parameters

Corresponding working parameters when the equipment is searching for cards.

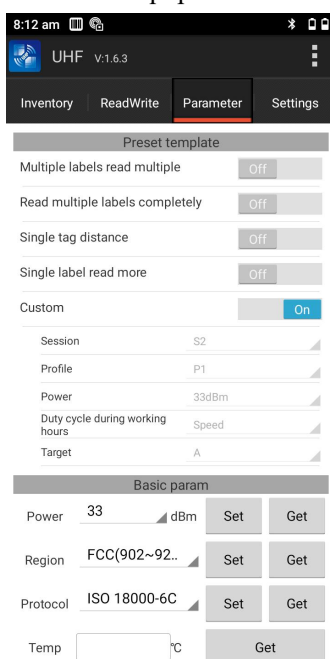

Figure 8-11 Query parameters

- Session: For different numbers and placement environments of tags, it is generally recommended to select S0\S1.
- Profile: For different tag chips, different tag placement environments have a greater impact. It is recommended to choose P1.
- Target: Select the status of target tag, side A by default.
- TagFocus: Suitable for quickly reading different tags (only for Impinj tags).
- FastID: When turned on, the data read by the device changes from EPC data to EPC+TID data (some tags do not support this function).
- Export data: When turned on, the card-searching data for each cycle will be saved in a txt file named with time in the system root directory.

3. Additional data

- When turned on, the additional data column of the inventory tag interface may display the additional data content of the read tag.
- Starting address: Select the address bits to read additional data.
- Length: Select the length to read additional data.
- Access password: The password used when enabling additional data, the same as the one for reading and writing tags.

- Enable additional data: After checking, click Set additional data to enable the function (not to be used together with FAST ID).

8.2.4 Application setting interface

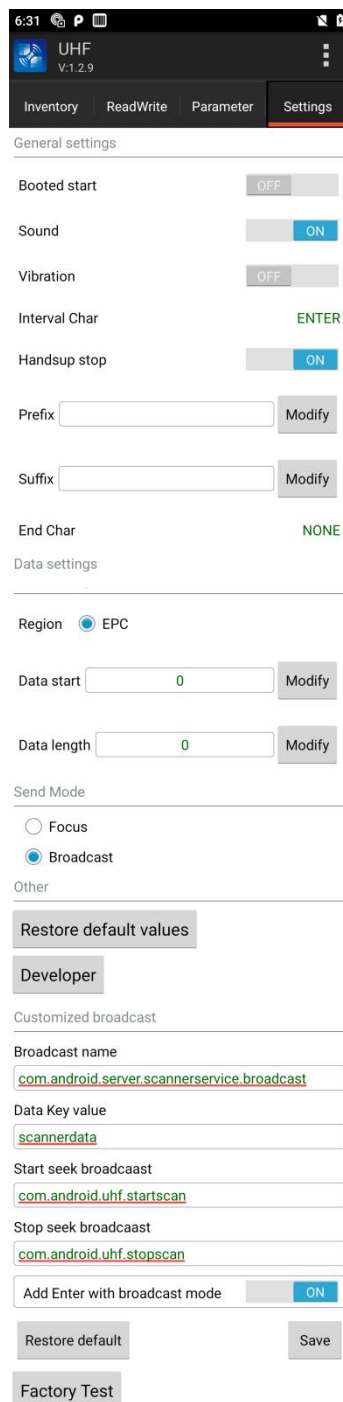

Figure 8-12 Application setting interface

1. General settings

- Boosted start: When turned on, the UHF program will automatically start when the device is

turned on.

- Sound: When turned on, there will be a sound prompt when the device is searching for a card.
- Vibration: When turned on, there will be a vibration prompt when the device is searching for a card.
- Interval Char: When turned on, the interval character selected here will be inserted between every two pieces of data found on the card (non-inventory tag interface).
- Handsup stop: In the enabled state, if you press and hold the Scan key, the card searching continues. It ends when you release the key.
- Prefix: Add the set prefix before the obtained tag ID. The prefix can be numbers, letters, special characters, etc. (non-inventory tag interface)
- Suffix: Add the set suffix after the obtained tag ID. The suffix can be numbers, letters, special characters, etc. (non-inventory tag interface).
- End Char: After obtaining the tag ID (which can be a group of tags), the following characters include: ENTER, TAB, SPACE, and NONE (NONE represents no ending character).

2. Data settings

- Data start: Enter the starting reading length of the searching card ID (with ID 012345678 as an example, when it's set to 3, the data will be read starting from the fourth digit).
- Data length: Total length of data read.

3. Sending method

- Focus input: The card searching data will be sent to any input interface with focus.
- Broadcast: The card searching data will be sent in the form of broadcast.

4. Others

- Restore default values: After clicking, the device application settings will be restored to factory settings.
- Developer: After clicking, the password input interface will pop up. After entering the password, you will enter the developer settings interface (default password: 888888).
- Broadcast name: Set the name of the broadcast sent.
- Data key value: Set the key value when receiving data.
- Start seek broadcast: Set the broadcast name to start card seeking.
- Stop seek broadcast: Set the broadcast name to stop card seeking.
- Add Enter with broadcast mode: The following Enter event when data is sent as broadcast.
- Restore default: After clicking, the developer item will be restored to the initialization state.

8.2.5 Menu key

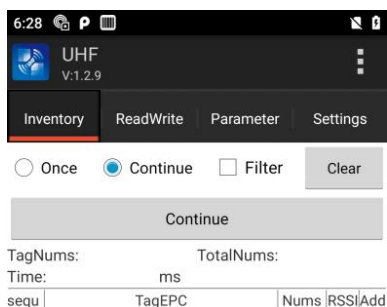



Figure 8-13 Menu key

Click the UHF  icon to pop up the menu and select Hide: The application will be hidden in the background; select Exit and the application will exit; select the firmware version to display the current UHF firmware version.

8.2.6 Troubleshooting

Issue	Cause	Solution
UHF card cannot be sought	Battery power too low	Charge or replace the battery
	Abnormal power settings	The default long-distance power is 33dbm.
	Error of UHF module	Exit the software and open it again or restart
	System breakdown	Perform a soft reset
Rechargeable battery can no longer be charged	Battery failure	Replace battery
	Battery temperature too high/low	Keep the battery in a normal-temperature environment

8.3 System upgrade

This application facilitates remote upgrade of customers.



1. Find this icon and enter [Updater], as shown below:

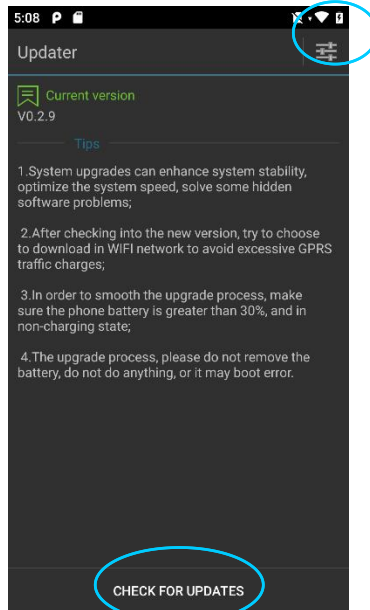

Figure 8-14 System upgrade

2. When the network is available, click the Check for Updates button. If there is no update, it will prompt that the current version is the latest; if there is an update, you will be prompted to update to a new version. Click to enter the download interface, as shown in the figure.

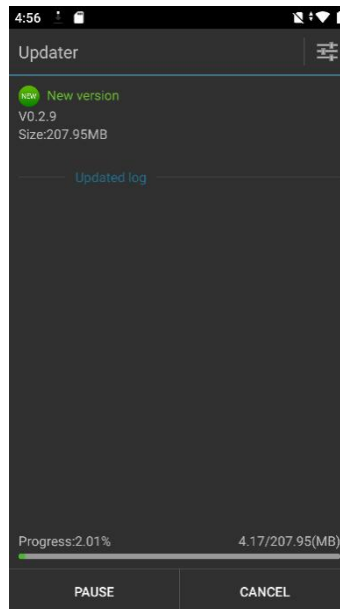

Figure 8-15 Check for updates and downloads

3. Click Download. After the download is successful, click Update Now, and the device will automatically restart and enter the upgrade state, as shown in the figure:

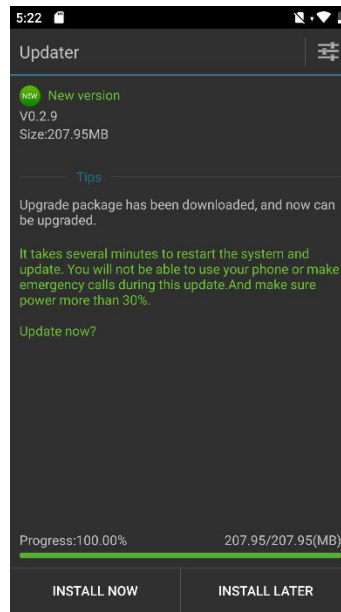

Figure 8-16 Update now

When the battery power is lower than 30%, the following prompt will appear and the upgrade cannot be performed.

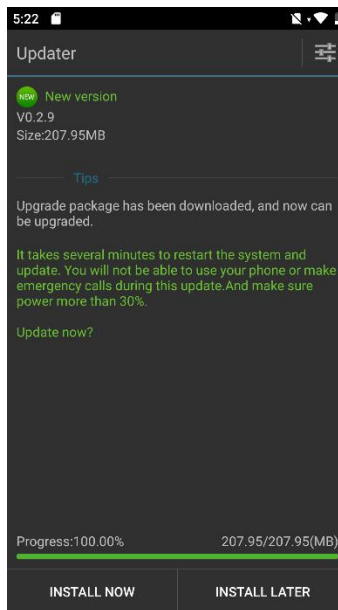

Figure 8-17 Low battery

4. System upgrade settings are shown in the figure below:

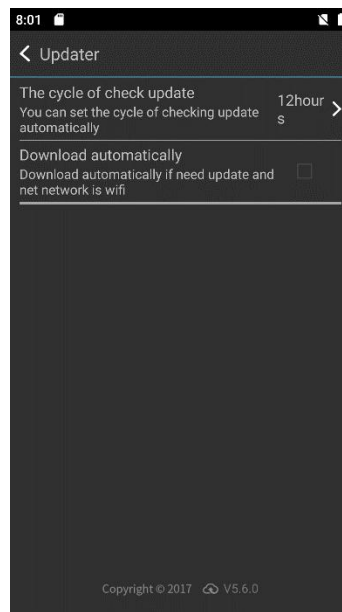

Figure 8-18 System upgrade

8.4 Quick configuration

This application is designed to quickly copy the configuration information of one device to another of the same model, so that the relevant configurations of the two devices are exactly the same.

Configurations cannot be imported between devices of different models.



Find this icon to enter the quick configuration interface;

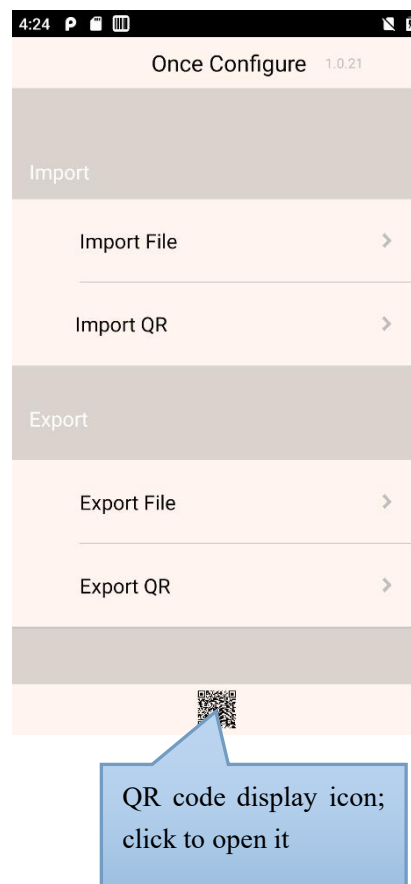

Figure 8-19 Main interface for quick configuration

8.4.1 Import

1. File import

Place the qualified configuration compressed package in the specified directory of the external SD card to import files. The system path for external SD card is: External SD card/SysSetting/Setinfo.tar.gz.

(1) Manual import:

1) Place the configuration compressed package (file name: Setinfo.tar.gz) in the external SD card/SysSetting directory, as shown in the figure:

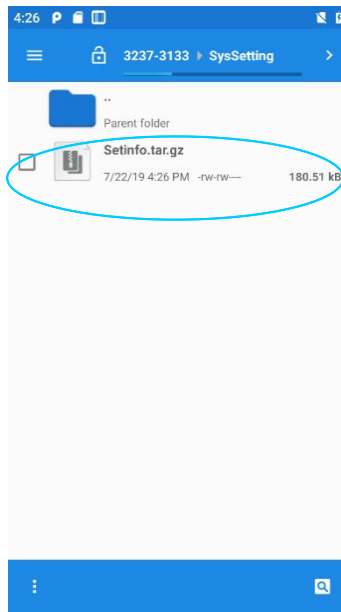

Figure 8-20 Directory for configuring the compressed package

2) Enter the quick configuration, click [Import File]; the following prompt will pop up, click [Confirm];

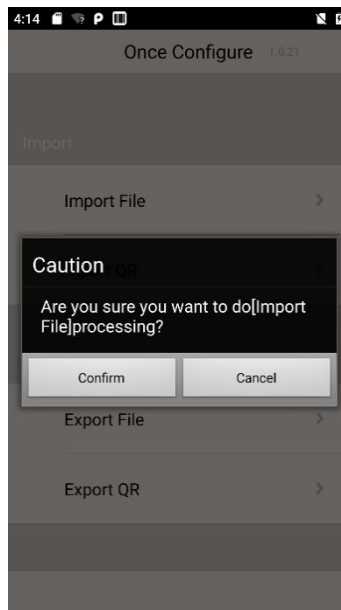

Figure 8-21 File import

3) After the import is done, the item and status of the file import will pop up. After clicking Confirm, a restart prompt will pop up. Click [Restart Now] to complete (some configurations will not take effect immediately if you do not restart).

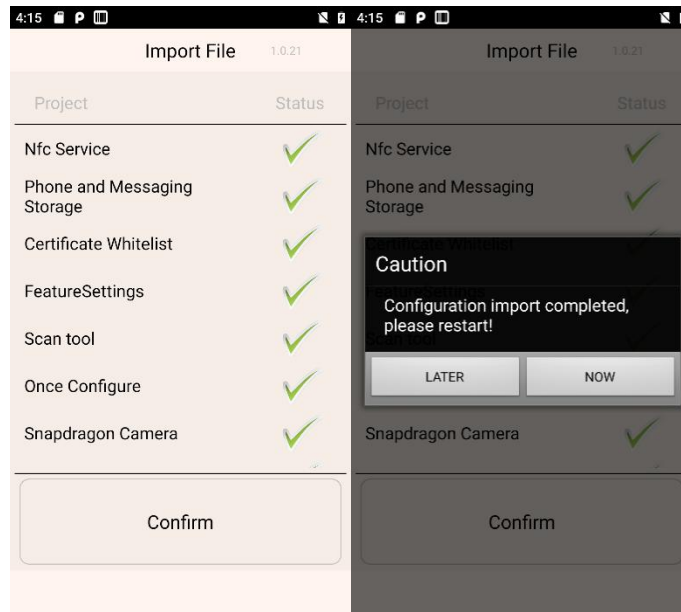

Figure 8-22 File configuration imported successfully

2. QR code import

This function enables importing external configuration files by scanning QR codes, and you can call the camera to scan other external QR codes to import configuration files.

(1) Enter the quick configuration, click [QR Code Import], and place the QR code to be imported into the scanning box, as shown in the following figure:



Figure 8-23 QR code import window

(2) After the scanning and transmission is successful, the item and status of QR code import will pop up. After clicking Confirm, a restart prompt will pop up. Click [Restart Now] to complete (some configurations will not take effect immediately if you do not restart).

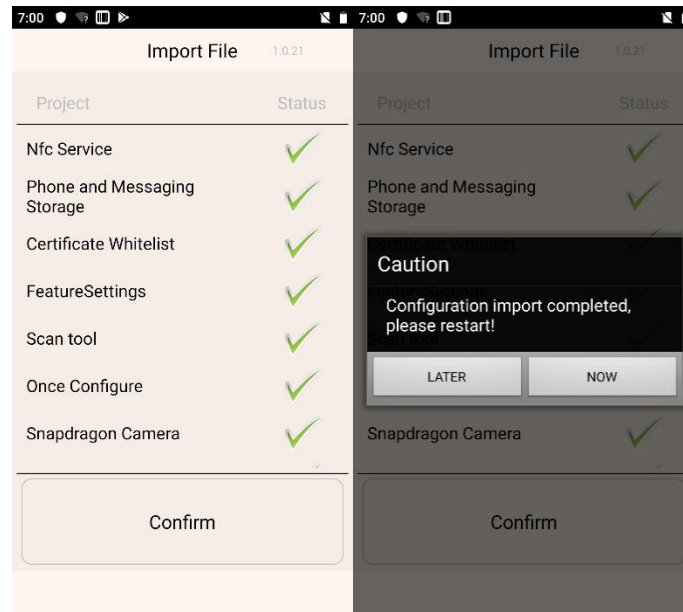

Figure 8-24 QR code imported successfully

8.4.2 Export

1. File export

This function enables exporting all the configuration items of the device in the configuration import and export tool, to the directory specified by the built-in SD card or the external SD card of the device. The name of the exported file is Setinfo.tar.gz. The path for file export is:

- External SD card/SysSetting/
- Internal SD card/SysSetting/

If the device has an external SD card, the exported file is first placed on the external SD card.

(1) Enter the quick configuration, click [Export File], and the following interface will pop up to indicate that the export is successful. When there is a configuration file in the external SD card, the export will give a prompt, and exporting again will overwrite the original one:

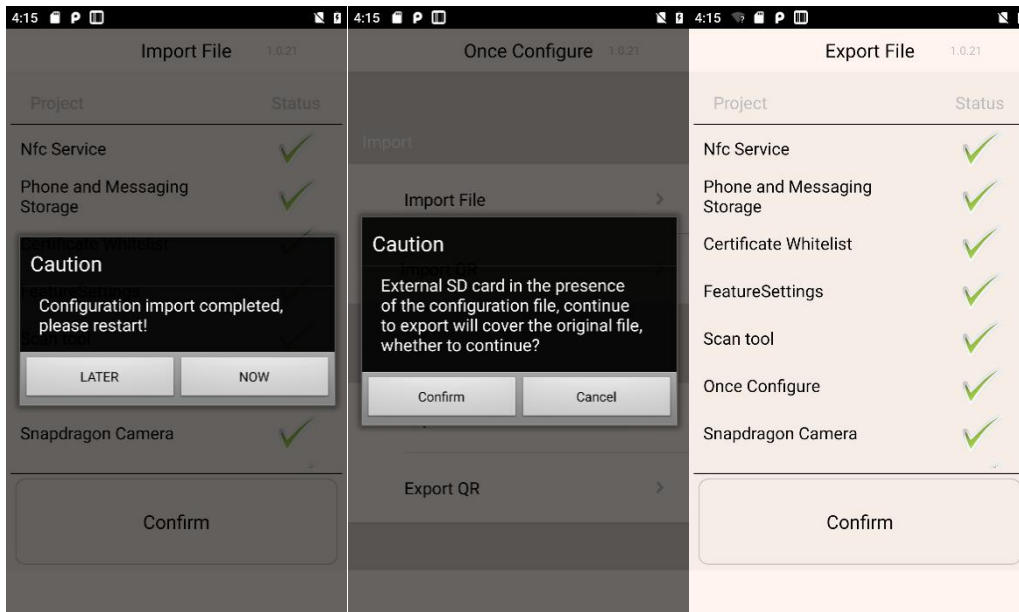

Figure 8-25 File export

(2) The name of the exported file is Setinfo.tar.gz, enter [File Management]---->[Phone Memory] OR [External Memory Card]---->[SysSetting] to view:

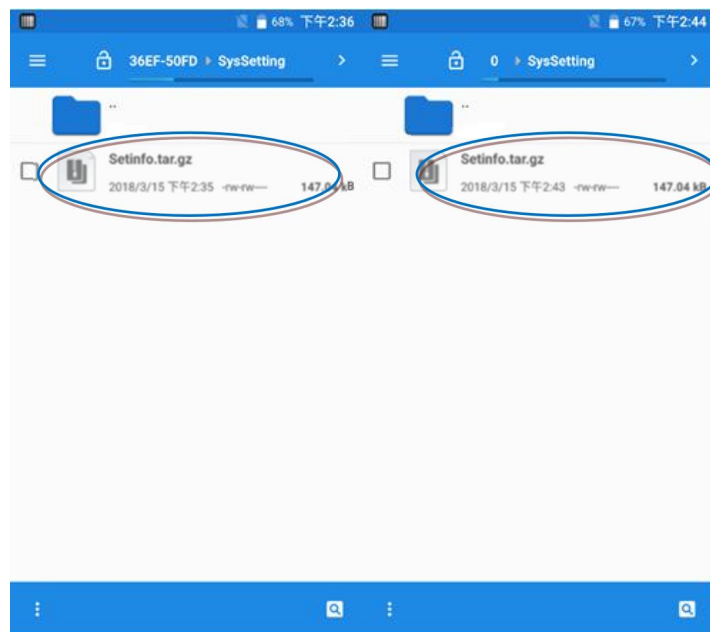

Figure 8-26 File export path

8.5 Feature settings

This application is used to quickly realize customer's special needs and help customers use it quickly.

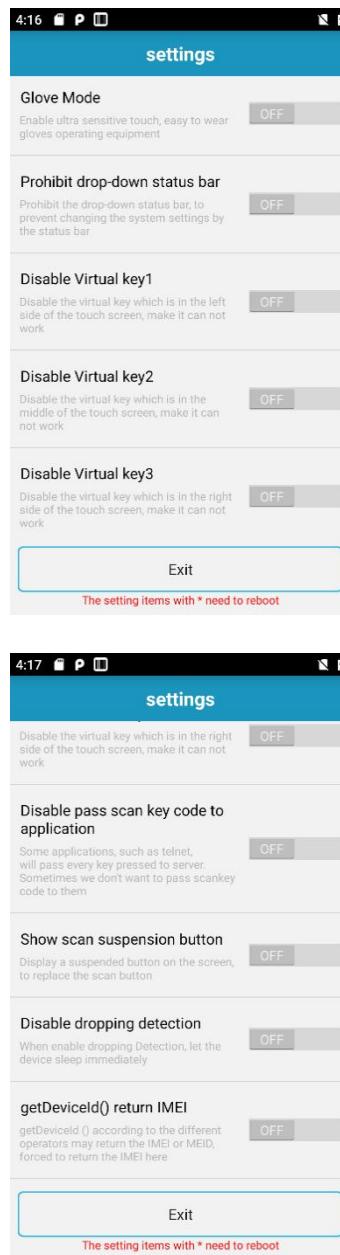

Figure 8-29 Feature settings

8.5.1 Glove mode of touch screen

- When turned on, this function enables operating the touch screen with gloves. In this scenario, the touch screen has a relatively high sensitivity;

8.5.2 Disable status pull-down

- Turned on: This function takes effect immediately to disable pulling down the menu.

- Turned off: This function takes effect immediately to enable pulling down the menu normally.

8.5.3 Virtual key for block 1

- Turned on: The virtual return key on the left side of the screen is disabled.
- Turned off: The virtual return key on the left side of the screen can respond and execute normally.

8.5.4 Virtual key for block 2

- Turned on: The virtual key in the middle of the screen is disabled.
- Turned off: The virtual Home key in the middle of the screen can respond normally.

8.5.5 Virtual key for block 3

- Turned on: The virtual key in the right side of the screen is disabled.
- Turned off: The virtual Menu key on the right side of the screen can respond and execute normally.

8.5.6 Prohibit passing the key value of the scan key to the application

- Turned on: Some applications, such as Telnet, will send all key values pressed to the server.
- Turned off: In some cases, prohibiting applications, such as Telnet, will send all key values pressed to the server.

8.5.7 Display Scan float button

- Turned off: The Scan float button is not displayed at the bottom of the interface
- Turned on: The Scan float button is hovering at bottom of any interface of the device. Click the scanning head to illuminate the barcode normally.

8.5.8 Disable drop detection

- Turned off: If the device drops accidentally, the system will automatically detect it and enter the screen-off sleep state.

- Turned on: In case of accidental fall, the system will not turn off the screen and sleep.

8.5.9 Allow File app to install applications from unknown sources (install third-party apk)

- Turned on (password: 4007770876)

Applications of unknown source can be installed in the File app

- Turned off

When installing an app from an unknown source in the File app, you are prompted to turn on the relevant options in the featured settings

Note: When installing an application from an unknown source in a non-file app, you need to turn on Allow applications from this source (a setting item will pop up during installation), and the password is 4007770876.

8.6 Digital certificate whitelist

This software is used to add specified digital certificates to the whitelist and use the digital certificates in the whitelist to sign applications. It allows direct installation when the system item "Unknown Source" is not turned on. The default application password is: 4007770876.

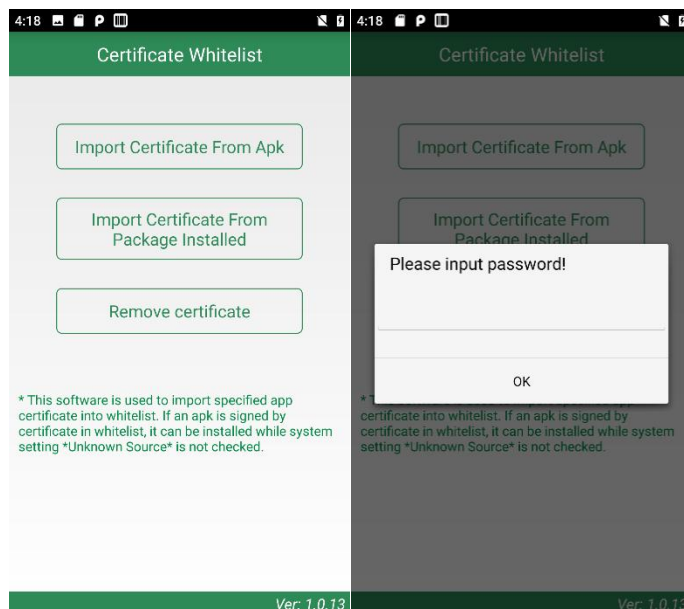

Figure 8-30 Digital certificate whitelist

1. Import the certificate in the APK file

The application will search for all APK files in the internal storage device directory and display their names and directories. The user can import the certificate in the selected APK file into the

system after checking a single or multiple display items and clicking the [Import] button.

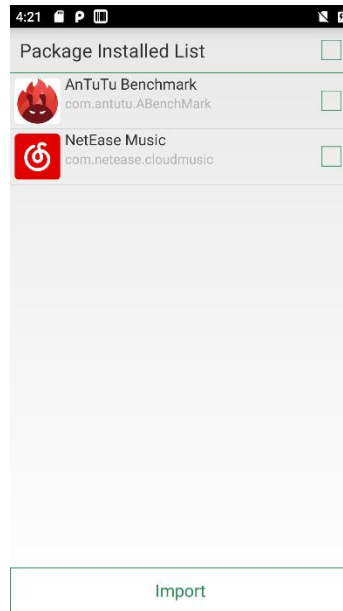

Figure 8-31 APK file import list

2. Import certificates in the installed package

The application will display the name of the third-party APP installed in the system and its package name. The user can import the certificate in the selected APK file into the system after selecting a single or multiple display items and clicking the [Import] button.

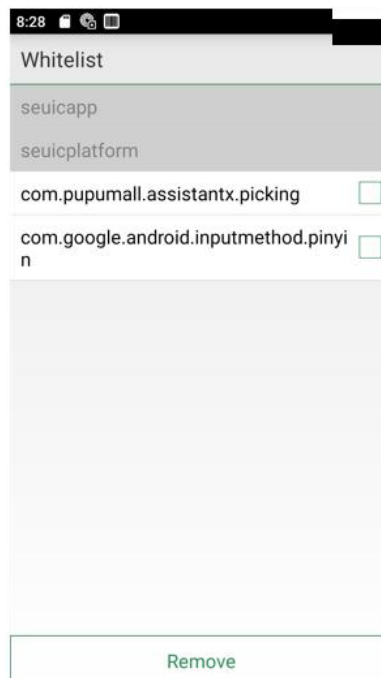

Figure 8-32 List of installed package names

3. Remove certificates from the whitelist

The application will display the name of the added certificate. Check a single or multiple display items and click [Remove] to remove the corresponding certificates from the whitelist. Items displayed in gray without check boxes are default system certificates that cannot be deleted.

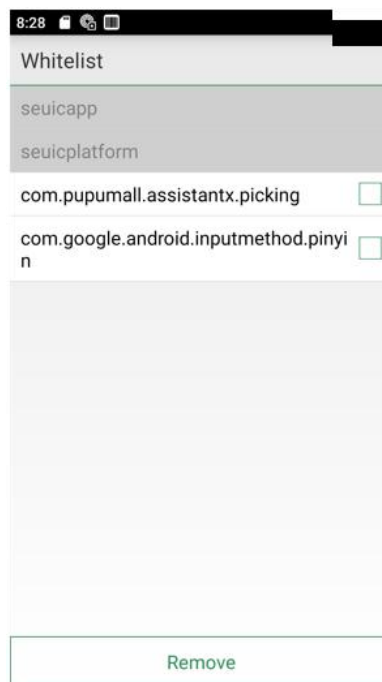

Figure 8-33 Signature whitelist categories

Precautions:

The added certificate will be named after the package name of the APP.

For certificates with the same content but different package names, only one record is saved, and it is named with the name when the first record is saved.

Chapter IX Troubleshooting

Issue	Cause	Solution
The device does not turn on after pressing the Power button	The battery is too low or not charged	Charge or replace the battery
	Short press	Press and hold for 3S
	Battery installed incorrectly	Battery installed correctly
	System breakdown	Perform a soft reset
Rechargeable battery can no longer be charged	Battery failure	Replace battery
	Battery temperature too high/low	Keep the battery in a normal-temperature environment
No sound	Volume is set too low or is muted	Adjust volume
Device automatically shuts down	Device is inactive	After a period of inactivity, the mobile data terminal is turned off. This time period can be set from 15S to 30Min, or never sleep.
	Battery exhausted	Charge or replace the battery
Barcode not decoded when reading	Scanning tool program is not turned on	Load scanning application
	In the barcode settings or application settings interface	Set the scanner to the scanning interface, or hide the scanner
	Barcode unreadable	Make sure the barcode is flawless
	Barcode decoding function is not enabled	Enter the barcode settings and enable the corresponding decoding
	The device does not support decoding of this barcode type	
	The distance between the device and the barcode is inappropriate.	Place the device within the correct scanning range.
Unable to connect to AP	It prompts "There was a problem with authentication"	WLAN password is incorrect

Can't take pictures	Prompt "No storage device"	Exit USB mode storage mode
	Prompt "Camera failure"	Turn off 2D. The camera cannot be turned on when 2D light is emitted.
	Prompt "Insufficient SD card storage capacity"	Clear memory or switch storage location
Can't get online using mobile data	Mobile data is not turned on	Go to settings and enable data network
	The incorrect network mode is selected, and the SIM card is not registered	Go to settings and select the correct network mode
	SIM card arrears	Recharge your SIM card promptly

Introduction to optional accessories

Please keep the original box and packaging materials for use when repairing or storing the device in the future. The following accessories can better improve your work, and you can choose and buy according to your needs.

- USB data cable
- Power adapter
- Removable battery